

Product Price Guide
&
catalog

2022 (ver 7.1 Nov)



CABLE LUG



ReyLuc



From PAGE 4 页起

TOOLS



From PAGE 15 页起

NEM-CEE



CEE Twislok

From PAGE 21 页起

LIMIT SWITCH



From PAGE 29 页起

WARNING

NANZHOU 南洲

From PAGE 34 页起

METERS



From PAGE 37 页起

WEATHERPROOF



From PAGE 47 页起

TIMER



From PAGE 52 页起

电线配件



铜管接线端子

LUGS & TERMINALS

CONNECTOR

工具



CRIMPING TOOLS

PIPE TOOLS 导管工具

防水插头/插座



CEE 防水插头/插座

PLUG & SOCKET

限位开关



LIMIT-MICRO SWITCH

CONTROL BUTTON

警报器



WARNING LIGHT - SIREN - ALARM BELL

电子表



DIGITAL METERS 数字仪表

防水开关



WEATHERPROOF SWITCH SOCKET

其它



USB SWITCH SOCKET

COVER

TIMER

DOORBELL



Page 5 & 6 页



Page 7 页



Page 8 页



Page 9 页



Page 9 页



Page 9 页



Page 10 页



Page 10 页



Page 10 页



Page 10 页



Page 11 页



Page 11 页



Page 11 页



Page 11 页



Page 12 页



Page 12 页



Page 13 页



Page 13 页



Page 13 页



Page 14 页



Page 14 页



Page 14 页



Page 14 页



ReyLuc



CABLE ACCESSORIES
接线配件



Cable Size 电线规格(mm ²)	Stud Hole Size 螺丝孔直径(M)	Item Code 型号	Qty/box 每小盒数量 (pcs)	List Price 大价 (RM/100pcs)
1.5mm ²	M5 (3/16")	RC1.5-5	5,000	14.50
1.5mm ²	M6 (1/4")	RC1.5-6	5,000	14.50
2.5mm ²	M5 (3/16")	RC2.5-5	4,000	20.00
2.5mm ²	M6 (1/4")	RC2.5-6	4,000	20.00
2.5mm ²	M8 (5/16")	RC2.5-8	4,000	33.00
4mm ²	M5 (3/16")	RC4-5	3,000	25.00
4mm ²	M6 (1/4")	RC4-6	3,000	25.00
4mm ²	M8 (5/16")	RC4-8	3,000	30.00
6mm ²	M6 (1/4")	RC6-6	1,800	36.00
6mm ²	M8 (5/16")	RC6-8	1,800	39.00
6mm ²	M10 (3/8")	RC6-10	1,800	55.00
10mm ²	M6 (1/4")	RC10-6	1,800	45.00
10mm ²	M8 (5/16")	RC10-8	1,800	45.00
10mm ²	M10 (3/8")	RC10-10	1,800	57.00
16mm ²	M6 (1/4")	RC16-6	1,000	68.00
16mm ²	M8 (5/16")	RC16-8	1,000	60.00
16mm ²	M10 (3/8")	RC16-10	1,000	62.00
16mm ²	M12 (1/2")	RC16-12	1,000	80.00
25mm ²	M6 (1/4")	RC25-6	700	110.00
25mm ²	M8 (5/16")	RC25-8	700	103.00
25mm ²	M10 (3/8")	RC25-10	700	103.00
25mm ²	M12 (1/2")	RC25-12	700	103.00
35mm ²	M6 (1/4")	RC35-6	500	155.00
35mm ²	M8 (5/16")	RC35-8	500	148.00
35mm ²	M10 (3/8")	RC35-10	500	142.00
35mm ²	M12 (1/2")	RC35-12	500	148.00
35mm ²	M16 (5/8")	RC35-16	500	170.00
50mm ²	M8 (5/16")	RC50-8	300	225.00
50mm ²	M10 (3/8")	RC50-10	300	208.00
50mm ²	M12 (1/2")	RC50-12	300	215.00
70mm ²	M8 (5/16")	RC70-8	150	370.00
70mm ²	M10 (3/8")	RC70-10	150	360.00
70mm ²	M12 (1/2")	RC70-12	150	340.00
70mm ²	M16 (5/8")	RC70-16	150	380.00
95mm ²	M8 (5/16")	RC95-8	100	550.00
95mm ²	M10 (3/8")	RC95-10	100	550.00
95mm ²	M12 (1/2")	RC95-12	100	525.00
95mm ²	M16 (5/8")	RC95-16	100	550.00
120mm ²	M10 (3/8")	RC120-10	90	725.00
120mm ²	M12 (1/2")	RC120-12	90	715.00
120mm ²	M16 (5/8")	RC120-16	90	725.00
150mm ²	M8 (5/16")	RC150-8	80	1030.00
150mm ²	M10 (3/8")	RC150-10	80	1000.00
150mm ²	M12 (1/2")	RC150-12	80	1000.00
150mm ²	M16 (5/8")	RC150-16	80	940.00

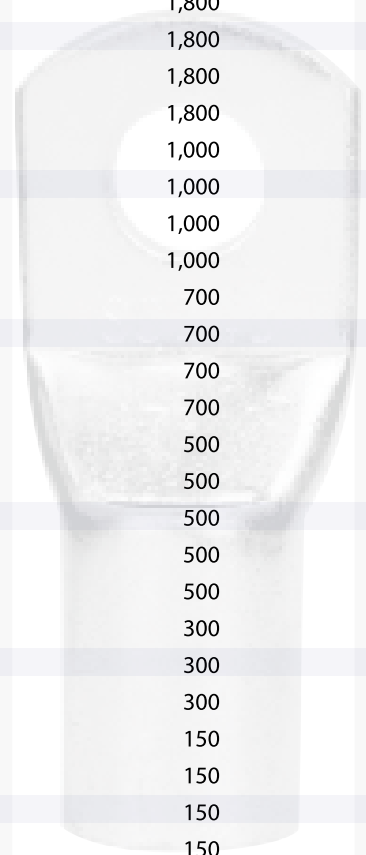
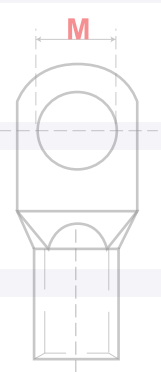
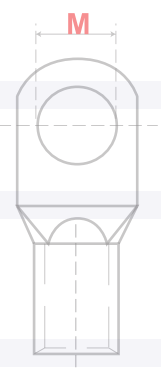

* Common Size in Highlight

* 突出显示的文字为通用型号

Crimping Tool 适用工具 Page 16 页



Cable Size 电线规格(mm ²)	Stud Hole Size 螺丝孔直径(M)	Item Code 型号	Qty/box 每小盒数量 (pcs)	List Price 大价 (RM/100pcs)
185mm ²	M10 (3/8")	RC185-10	50	1,350.00
185mm ²	M12 (1/2")	RC185-12	50	1,350.00
185mm ²	M14 (1/2")	RC185-14	50	1,500.00
185mm ²	M16 (5/8")	RC185-16	50	1,290.00
240mm ²	M12 (1/2")	RC240-12	40	2,050.00
240mm ²	M16 (5/8")	RC240-16	40	1,900.00
300mm ²	M12 (1/2")	RC300-12	30	3,250.00
300mm ²	M16 (5/8")	RC300-16	30	2,900.00
400mm ²	M12 (1/2")	RC400-12	15	4,600.00
400mm ²	M16 (5/8")	RC400-16	15	4,300.00
500mm ²	M16 (5/8")	RC500-16	10	6,500.00
500mm ²	M20 (3/4")	RC500-20	10	6,100.00
630mm ²	M20 (3/4")	RC630-20	8	9,000.00

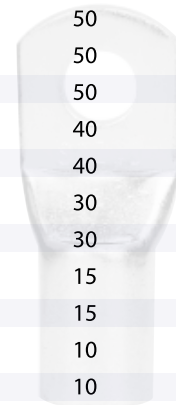
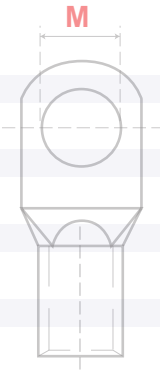

* Common Size in Highlight
* 突出显示的文字为通用型号

Crimping Tool 适用工具 Page 16 页

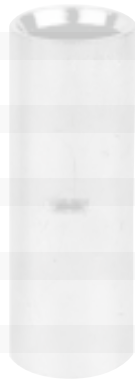

ReyLuc Cable Link

Cable Size 电线规格(mm ²)	Item Code 型号	Qty/box 每小盒数量 (pcs)	List Price 大价 (RM/100pcs)
1.5mm ²	RL1.5	5,000	21.00
2.5mm ²	RL2.5	4,000	26.00
4mm ²	RL4	3,000	35.00
6mm ²	RL6	2,500	44.00
10mm ²	RL10	1,500	66.00
16mm ²	RL16	700	88.00
25mm ²	RL25	400	130.00
35mm ²	RL35	300	190.00
50mm ²	RL50	200	260.00
70mm ²	RL70	150	385.00
95mm ²	RL95	100	575.00
120mm ²	RL120	90	800.00
150mm ²	RL150	80	1,100.00
185mm ²	RL185	50	1,500.00
240mm ²	RL240	30	2,100.00
300mm ²	RL300	25	3,000.00
400mm ²	RL400	15	4,200.00
500mm ²	RL500	10	6,100.00
630mm ²	RL630	8	9,300.00



Crimping Tool 适用工具 Page 16 页



Type 款型	Cable Size 电线规格(mm ²)	Dimension 尺寸(mm)		Item Code 型号	Qty/box 每小盒数量 (pcs)	List Price 大价 (RM/100pcs)
		W	d			
Insulated Y-型绝缘端子						
	1.5mm ²	5.7	3.2	VF1.25-3YSA	3,500	10.50
		5.7	3.7	VF1.25-3YS	3,500	10.50
		6.4	4.3	VF1.25-4YS	3,500	11.30
		8.0	5.3	VF1.25-5Y	3,000	11.50
		10.7	6.7	VF1.25-6Y	2,500	15.00
	2.5mm ²	5.7	3.2	VF2-3YSA	3,000	12.00
		5.7	3.7	VF2-3YS	3,000	12.00
		6.4	4.3	VF2-4YS	3,000	13.00
		8.0	5.3	VF2-5Y	3,000	14.00
		10.7	6.7	VF2-6Y	2,000	18.00
		14.0	8.4	VF2-8Y	1,000	34.00
	4 - 6mm ²	8.2	3.7	VF5.5-3YS	1,200	27.00
		8.2	4.3	VF5.5-4Y	1,000	28.00
		9.0	5.3	VF5.5-5Y	1,000	29.00
		12.0	6.4	VF5.5-6Y	1,000	33.00
		14.0	8.4	VF5.5-8Y	800	51.00

Crimping Tool 适用工具 (HS-30J) Page 17 页

非绝缘Y-型

Non-Insulated Spade Terminals (Y-Lug)











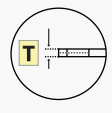

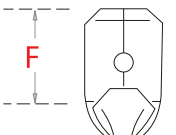



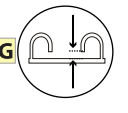

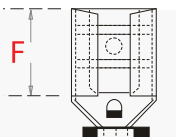
Type 款型	Cable Size 电线规格(mm ²)	Dimension 尺寸 (mm)		Item Code 型号	Qty/box 每小盒数量 (pcs)	List Price 大价 (RM/100pcs)
		W	d			
	1.5mm ²	5.7	3.7	1.25-3YS	9,000	9.50
		6.4	4.3	1.25-4YS	8,000	10.30
		8.0	5.3	1.25-5Y	5,000	14.00
		10.7	6.7	1.26-6Y	3,500	17.00
		5.7	3.7	2-3YS	6,500	11.50
2.5mm ²	6.4	4.3	2-4YS	6,000	12.00	
	8.0	5.3	2-5Y	6,000	13.00	
	10.7	6.7	2-6Y	3,000	19.00	
4 - 6mm ²	8.2	3.7	5.5-3Y	2,000	30.00	
	8.2	4.3	5.5-4Y	2,000	30.00	
	9.0	5.3	5.5-5Y	2,000	31.00	
	12.0	6.4	5.5-6Y	1,500	41.00	

Crimping Tool 适用工具 (HS-101) Page 17 页

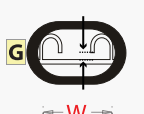

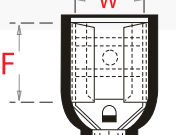
Type 款型	Cable Size 电线规格(mm ²)	Dimension 尺寸 (mm)		Item Code 型号	Qty/box 每小盒数量 (pcs)	List Price 大价 (RM/100pcs)		
Insulated 圆型绝缘								
	1.5mm ²	W	d					
		5.5	3.2	VF1.25-3A	3,500	9.00		
		5.5	3.7	VF1.25-3	3,500	9.00		
		8.0	4.3	VF1.25-4	3,500	12.00		
		6.6	4.3	VF1.25-4M	3,500	11.00		
		8.0	5.3	VF1.25-5	3,000	13.00		
		11.6	6.4	VF1.25-6	2,500	19.00		
		11.6	8.4	VF1.25-8	2,000	19.00		
		13.6	10.5	VF1.25-10	2,000	31.00		
			2.5mm ²	6.6	3.7	VF2-3M	3,000	13.00
8.5	4.3			VF2-4	3,000	16.00		
6.6	4.3			VF2-4M	3,000	13.00		
9.5	5.3			VF2-5	2,500	16.50		
12.0	6.4			VF2-6	2,000	23.00		
12.0	8.4			VF2-8	2,000	24.00		
13.6	10.5			VF2-10	2,000	31.00		
	4 - 6mm ²			7.2	3.7	VF5.5-3	1,000	33.00
				9.5	4.3	VF5.5-4	1,000	33.00
				9.5	5.3	VF5.5-5	1,000	33.00
		12.0	6.4	VF5.5-6S	1,000	38.00		
		15.0	8.4	VF5.5-8	1,000	45.00		
		15.0	10.5	VF5.5-10	1,000	45.00		
		18.2	13.2	VF5.5-12	800	48.00		
Non-insulated 非绝缘								
	1.5mm ²	5.5	3.7	1.25-3	5,000	11.50		
		6.6	4.3	1.25-4M	7,000	10.00		
		8.0	5.3	1.25-5	7,000	11.00		
		11.6	6.4	1.25-6	5,000	23.00		
		11.6	8.4	1.25-8	3,000	23.00		
		13.6	10.5	1.25-10	2,000	30.00		
		18.0	13.0	1.25-12	1,000	35.00		
			2.5mm ²	6.6	3.7	2-3M	6,500	14.00
				6.6	4.3	2-4M	6,500	12.00
				9.5	5.3	2-5	6,000	16.00
12.0	6.4			2-6	4,000	20.00		
12.0	8.4			2-8	4,000	21.00		
13.6	10.5			2-10	3,000	29.00		
	4 - 6mm ²	19.2	13.0	2-12	3,000	36.00		
		9.5	3.7	5.5-3	3,000	31.00		
		9.5	4.3	5.5-4	3,000	29.00		
		9.5	5.3	5.5-5	3,000	32.00		
		12.0	6.4	5.5-6S	3,000	34.00		
		15.0	8.4	5.5-8	2,000	46.00		
		15.0	10.5	5.5-10	2,000	43.00		
		19.2	13.0	5.5-12	1,000	64.00		
			10.0mm ²	10.0	4.3	LY8-4	500	80.00
			16.0mm ²	22.0	13.0	LY12-16	500	250.00

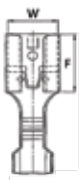

Type 款型	Cable Size 电线规格(mm ²)	Dimension 尺寸 (mm)			Item Code 型号	Qty/box 每小盒数量 (pcs)	List Price 大价 (RM/100pcs)		
		W	F	T					
Male 公									
	1.5mm ²		2.8	6.5	0.5	RM110-5	3,000	17.60	
			2.8	6.5	0.8	RM110-8	3,000	17.60	
			4.5	6.5	0.5	RM187-5	3,000	17.60	
			6.3	7.7	0.8	RM250	3,000	16.50	
	2.5mm ²		2.8	6.5	0.5	BM110-5	3,000	17.60	
			4.5	6.5	0.5	BM187-5	3,000	18.70	
			6.3	7.7	0.8	BM250	3,000	17.00	
	4 - 6mm ²		6.3	7.7	0.8	YM250	2,000	20.00	
Female 母									
	1.5mm ²		3.2	6.5	0.3	RF110-5	3,000	19.60	
			5.0	6.4	0.3	RF187-5	3,000	19.60	
			5.0	6.4	0.4	RF187-8	3,000	19.60	
			6.6	7.3	0.4	RF250	3,000	18.00	
	2.5mm ²		3.2	6.5	0.3	BF110-5	3,000	19.60	
			5.0	6.4	0.3	BF187-5	3,000	19.60	
			5.0	6.4	0.4	BF187-8	3,000	19.60	
			6.6	7.3	0.4	BF250	2,500	18.00	
	4 - 6mm ²		6.6	7.3	0.4	YF250	1,500	21.00	
Female 全绝缘插鞘母端子									
	1.5mm ²		3.2	6.5	0.3	RF110F-5	2,000	26.00	
			5.0	6.4	0.4	RF187F-5	2,000	26.00	
			6.6	7.3	0.4	RF250F	1,500	25.00	
	2.5mm ²		3.2	6.5	0.3	BF110F-5	2,000	26.00	
			5.0	6.4	0.4	BF187F-5	2,000	26.00	
			6.6	7.3	0.4	BF250F	1,500	26.00	
	4 - 6mm ²		6.6	7.3	0.4	YF250F	1,000	34.00	
Open Barrel (M/F) 平網公母端子									
Male 公		Female 母			6.0	15.6	1661-BS-0	3,000	23.00
					7.4	7.5	1764-BS-0	3,000	21.00
					7.4	7.5	1761-BS-0	3,000	23.00

Crimping Tool 适用工具 Page 17 页



Type 款型	Cable Size 电线规格(mm ²)	Dimension 尺寸(mm)		Item Code 型号	Qty/box 每小盒数量 (pcs)	List Price 大价 (RM/100pcs)	
		W	F				
Male 公							
	1.5mm ²		4.0	8.5	F1.25A	2,500	18.00
	2.5mm ²		4.0	8.5	F2A(4)	2,500	19.00
			5.0	8.5	F2A(5)		23.00
	4 - 6mm ²		5.0	8.5	F5.5A	2,000	24.00
Female 母							
	1.5mm ²		3.9	7.3	F1.25B	2,000	24.00
	2.5mm ²		3.9	7.3	F2B(4)	1,500	25.00
			4.9	7.0	F2B(5)		29.00
	4 - 6mm ²		4.9	7.0	F5.5B	1,000	35.00

钩型公母插

Piggyback Insulated Disconnectors (Taiwan)

Type 款型	Cable Size 电线规格(mm ²)	Dimension 尺寸(mm)		Item Code 型号	Qty/box 每小盒数量 (pcs)	List Price 大价 (RM/100pcs)	
		W (W1)	F (F1)				
	1.5mm ²		6.8 (6.3)	8.0 (8.2)	MF1.25	1,600	37.00
	2.5mm ²		6.8 (6.3)	8.0 (8.2)	MF2	1,500	38.00
			6.8 (6.3)	8.0 (8.2)	MF5.5		46.00

绝缘中间套管

Insulated Link

Type 款型	Cable Size 电线规格(mm ²)	Dimension 尺寸(mm)		Item Code 型号	Qty/box 每小盒数量 (pcs)	List Price 大价 (RM/100pcs)	
		L	d				
	1.5mm ²		23.0	2.0	BF1.25	2,000	16.00
	2.5mm ²		23.2	2.4	BF2	1,800	18.00
			25.5	3.6	BF5.5		32.00



Type 款型	Cable Size 电线规格(mm ²)	Dimension 尺寸(mm)	Item Code 型号	Qty/box 每小盒数量 (pcs)	List Price 大价 (RM/100pcs)	
		<u>W</u> <u>F</u>				
	1.5mm ²		PIN1.25F10	3,000	19.00	
			PIN1.25F14	3,000	19.00	
			PIN1.25F18	2,500	19.00	
	2.5mm ²		PIN2F10	2,500	22.00	
			PIN2F13	2,500	20.00	
			PIN2F18	2,500	20.00	
4-6mm ²		PIN5.5F10	1,500	33.00		
		PIN5.5F18	1,500	38.00		
Non-insulated 裸体平板型	1.5mm ²		TPIN1.25F10	5,000	19.00	
			TPIN1.25F14	5,000	19.00	
			TPIN1.25F18	3,000	19.00	
	2.5mm ²		TPIN2F10	5,000	23.00	
			TPIN2F14	4,000	23.00	
			TPIN2F18	4,000	20.00	
4-6mm ²		TPIN5.5F18	2,500	36.00		
	Round Pin 圆型针		1.5mm ²	PIN1.25	2,500	16.00
			2.5mm ²	PIN2	2,500	19.00
			4-6mm ²	PIN5.5	1,500	38.00
	Non-insulated 裸体圆型		1.5mm ²	TPIN1.25	5,000	15.00
			2.5mm ²	TPIN2	5,000	20.00
			4-6mm ²	TPIN5.5	3,000	42.00
	CP 扁形铜管端子		10mm ²	CP10	1,800	125.00
			16mm ²	CP16	1,200	185.00
			25mm ²	CP25	800	260.00
			35mm ²	CP35	500	440.00
			50mm ²	CP50	300	580.00
			10mm ²	KS10-12	1,500	90.00
	KS(Taiwan) 裸体平板型		16mm ²	KS16-13	1,000	156.00
			25mm ²	KS25-15	500	236.00
			35mm ²	KS35-20	300	400.00
			50mm ²	KS50-20	200	565.00
			70mm ²	KS70-25	150	900.00
			95mm ²	KS95-25	100	1,295.00
			120mm ²	KS120-34	90	1,950.00
			150mm ²	KS150-37	60	2,200.00
			185mm ²	KS185-38	40	3,150.00
240mm ²	KS240-44	30	4,700.00			



Type 款型	Cable Size 电线规格 (mm ²)	Dimension 尺寸 (mm)		Item Code 型号	Colour 绝缘颜色	List Price 大价 (RM/100pcs)
		F (铜管长度)	C			
	0.25mm ²	8.0	0.75	LT02508	Light Blue 浅蓝	10.30
		6.0	1.0	LT05006	Orange 橙	7.80
	0.5mm ²	8.0	1.0	LT05008		7.40
		10.0	1.0	LT05010		8.00
	0.75mm ²	6.0	1.2	LT07506		White 白
		8.0	1.2	LT07508	7.50	
		10.0	1.2	LT07510	8.70	
		12.0	1.2	LT07512	8.70	
	1mm ²	8.0	1.4	LT10008	Red 红	12.30
		6.0	1.4	LT10006	Yellow 黄	7.80
	1mm ²	8.0	1.4	LT10008		7.40
		10.0	1.4	LT10010		9.00
1.5mm ²	12.0	1.4	LT10012	10.50		
	8.0	1.7	LT15008	Black 黑	11.40	
1.5mm ²	8.0	1.7	LT15008	Red 红	7.40	
	10.0	1.7	LT15010		8.30	
	12.0	1.7	LT15012		8.40	
2.5mm ²	8.0	2.2	LT25008	Blue 蓝	8.00	
	10.0	2.2	LT25010		9.50	
	12.0	2.2	LT25012		9.80	
4mm ²	10.0	2.8	LT40010	Grey 灰	14.50	
	12.0	2.8	LT40012		14.70	
6mm ²	12.0	3.5	LT60012	Black 黑	15.50	
10mm ²	12.0	4.5	LT100012	Ivory 象牙色	18.50	
16mm ²	12.0	5.8	LT160012	Green 绿	27.00	
25mm ²	16.0	7.3	LT250016	Brown 褐色	47.00	
35mm ²	16.0	8.3	LT350016	Beige 米色	54.00	
50mm ²	20.0	10.3	LT500020	Olive 橄榄色	123.00	
70mm ²	21.0	13.5	LT700021	Yellow 黄	300.00	
95mm ²	25.0	14.7	LT950025	Red 红	375.00	
120mm ²	27.0	16.7	LT1200027	Blue 蓝	440.00	

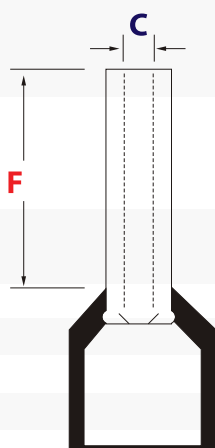

双绝缘欧式端子 (台湾) Twin Cord-end Terminal

Type 款型	Cable Size 电线规格 (mm ²)	Dimension 尺寸 (mm)		Item Code 型号	Colour 绝缘颜色	List Price 大价 (RM/100pcs)
		F (铜管长度)	C			
	0.5mm ²	8.0	1.5	CT2-05008	Orange 橙	17.80
		0.75mm ²	8.0	1.8	CT2-07508	White 白
	1mm ²	8.0	2.05	CT2-10008	Yellow 黄	16.50
		8.0	2.3	CT2-15008	Red 红	16.50
	2.5mm ²	10.0	2.8	CT2-25010	Blue 蓝	20.00
	4mm ²	12.0	3.7	CT2-40012	Grey 灰	40.00

Crimping Tool 适用工具 Page 18 页

Type 款型	Dimension 尺寸 C (mm)	Suitable Wire range 电线容量 (估计)		Item Code 型号	Qty/box (pcs)	List Price 大价 (RM/100pcs)	
		Max 最大	Min 最小				
		2.6	(2x0.5 + 1x0.8)mm ²	2 x 0.5mm ²	SD1.25	2,500	12.80
		3.0	(1x0.8 + 1x2.0)mm ²	2 x 0.5mm ²	SD2	1,800	13.70
		4.0	3 x 2.0mm ²	(2x0.5 + 2x0.8)mm ²	SD5.5	800	23.00

Crimping Tool 适用工具 Page 17 页

弹簧螺式接头

Wire-Nut Connectors (Taiwan)



Type 款型	Suitable Wire (flexible) range 电线容量 (估计)		Colour 颜色	Item Code 型号	Qty/box (pcs)	List Price 大价 (RM/100pcs)
	Max 最大	Min 最小				
	2 x 1.25mm ²	2 x 0.3mm ²	Grey	SP1	1,400	11.30
	3 x 1.25mm ²	2 x 0.3mm ²	Blue	SP2	800	13.00
	(4x1.25 + 1x0.5)mm ²	(1x0.8 + 1x0.5)mm ²	Orange	SP3	500	17.00
	(2x3.0 + 2x2.0)mm ²	3 x 0.5mm ²	Yellow	SP4	400	24.50
	(2x5.25 + 2x3.30)mm ²	2 x 2.0mm ²	Red	SP5	300	38.00

塑料套管

Vinyl End Cap (Taiwan)

Type 款型	Cable Lug Size 端子规格 (mm ²)	Dimension 尺寸(mm)		Item Code 型号	Qty/bag (pcs)	List Price 大价 (RM/100pcs)	
		D1	D2				
	1.5 mm ²	3.3	3.1	V1.25	100	6.70	
	2.5 mm ²	4.5	3.7	V2	100	7.80	
	4 mm ²	5.7	4.1	V3.5	100	8.70	
	6 mm ²	5.7	5.2	V5.5	100	9.60	
	10 mm ²	7.2	6.2	V8	100	13.40	
	16 mm ²	10.0	8.0	V14	100	18.20	
	25/35 mm ²	12.0	9.5	V22	100	24.50	
	50 mm ²	14.0	11.8	V38	100	31.00	
	70 mm ²	17.0	13.9	V60	100	48.00	
	95 mm ²	19.0	16.0	V80	50	74.00	
	120 mm ²	22.0	18.0	V100	50	103.00	
	150 mm ²	24.0	22.0	V125	50	127.00	
	185 mm ²	26.0	22.0	V150	50	132.00	
	240 mm ²	32.2	24.0	V200	50	170.00	
	300 mm ²	36.5	27.2	V250	50	190.00	
350 mm ²	36.7	30.0	V325	25	226.00		
400 mm ²	45.1	37.5	V400	25	390.00		
500 mm ²	48.2	40.2	V500	25	480.00		
630 mm ²	53.8	45.2	V630	25	725.00		
	Brown/White/Grey/褐色/白色/灰色	6 mm ²	5.7	5.2	V5.5	100	14.00
		10 mm ²	7.2	6.2	V8	100	17.00
		16 mm ²	10.0	8.0	V14	100	24.00
		25/35 mm ²	12.0	9.5	V22	100	32.00
		50 mm ²	14.0	11.8	V38	100	40.00
	70 mm ²	17.0	13.9	V60	100	61.00	

Note : V5.5 no White / 注明: V5.5 没有白色

Type 款型	Ampere (A) 适用电流	Item Code 型号	Qty/box (pcs)	List Price 大价 (RM/pc)
PVC Connector 透明塑料接线排				
	10A	H10PE	500	1.80
	20A	H20PE	400	3.00
	30A	H30PE	300	4.30
	60A	F60PE	200	10.00
Nylon Connector 高温 - 奶白色				
	10A	H10PA	500	2.60
	20A	H20PA	400	4.10
	30A	H30PA	300	5.30
	10A	HB10PA/ZN	500	3.30
For transformer/Autotrans 适用变压器 :				

Piercing Connector 绝缘穿刺线夹

Applicable Wire range 适用电线	Item Code 型号	Qty/box (pcs)	List Price 大价 (RM/pc)
95-16 mm ²	IPC3.1	100	7.30
95-50 mm ²	IPC3.2	100	8.00
185-120 mm ²	IPC3.3	100	11.50
185-70 mm ²	IPC3.4	40	24.50
Dead-end Clamp 绝缘耐张线夹			
Applicable Wire range 适用电线 16-25 mm ²	DC2.1	100	11.00



IPC 3.1



IPC 3.2



IPC 3.3



IPC 3.4



DC 2.1

电线接头C-型夹(纯铜)**Copper C-Clamp**

Type 款型	Applicable Wire range 适用电线	Item Code 型号	List Price 大价 (RM/pc)	
	Wire in 主线截面	Wire out 分支截面		
	25 mm ² - 16 mm ²	25 mm ² - 16 mm ²	CRC5	5.00
	35 mm ² - 35 mm ²	35 mm ² - 16 mm ²	CRC7	10.00
	70 mm ² - 50 mm ²	70 mm ² - 35 mm ²	CRC9	20.00
	95 mm ² - 70 mm ²	70 mm ² - 35 mm ²	CRC11	34.00
	95 mm ² - 95 mm ²	95 mm ² - 95 mm ²	CRC12	35.00
	120 mm ² - 120 mm ²	120 mm ² - 25 mm ²	CRC13	36.00



Page 16 页

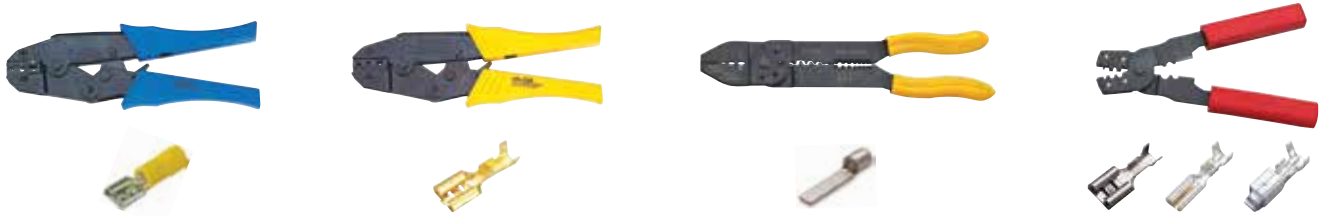

Page 17 页

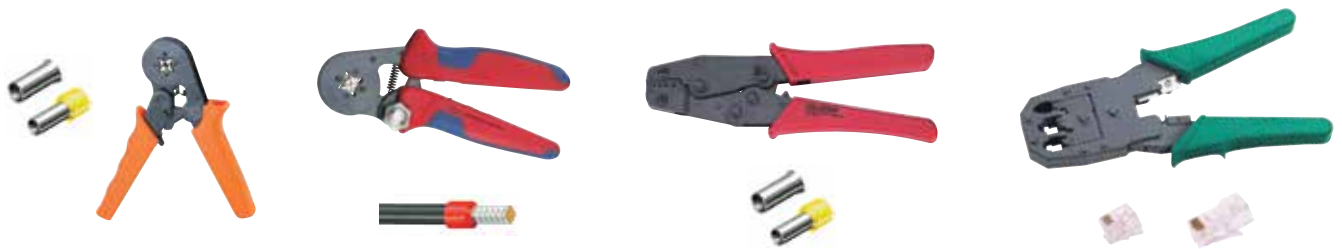

Page 18 页



Page 19 页



Page 20 页





Die set 钳口	Range of Application 应用范围	Item Code 型号	Crimping Range (mm ²) (压接范围)	List Price大价 (RM/pc)
(Point type 压后呈点式)				
		HD6	0.5 - 6.0 mm ²	52.00
		HS8	1.25 - 10.0 mm ²	60.00
	(Point type) (压后呈点式)	HS16	1.5 - 16.0 mm ²	63.00
		HS22	6.0 - 25.0 mm ²	113.00
		HS38	6.0 - 35.0 mm ²	115.00
		CT38	10 - 35 mm ²	195.00
		CT80	10 - 95 mm ²	278.00
		CT150	16 - 150 mm ²	360.00
(Hexagonal type 压后呈六角形)				
		HX16	6.0 - 16.0 mm ²	63.00
		HX26B	6.0 - 25.0 mm ²	113.00
	(Hexagonal type) (压后呈六角形)	HX50SC	6 - 50 mm ²	148.00
		HX120SC	10 - 120 mm ²	265.00
		HX150SC	25 - 150 mm ²	280.00
Hydraulic Crimping Tool 快速液压钳	(Hexagonal type) (压后呈六角形)	YQK300	10 - 300 mm ²	290.00

Die set 钳口	Range of Application 应用范围	Item Code 型号	Crimping Range 压接范围 (mm ²)	List Price大价 (RM/pc)
棘轮式压接钳(欧洲型)				
		HS30J	0.5 - 6.0 mm ²	52.00
		HS101	0.5 - 10.0 mm ²	52.00
		HS03BC	0.5 - 6.0 mm ²	52.00
		HS07FL	1.5 - 2.5 mm ²	60.00
		HS056FL	0.5 - 1.5 mm ² 0.5 - 2.5 mm ²	115.00
		HS103	0.5 - 6.0 mm ²	60.00
	RG59 RG6	HS02H1	1.0 - 6.5 mm ²	52.00
	太阳能端子 (MC4 卷压) Solar connectors	HS2546B	2.5, 4.0, 6.0 mm ²	52.00
	车削端子 Turned Contacts	HS-HT4	0.14-1.0, 1.5, 2.5, 4.0 mm ²	148.00
多功能压接钳 Multi Functional Crimping Pliers				
	5-in-1 Functions : Stripping, Cutting & Crimping 5合1: 剥线, 剪线, 压接裸体端子	HS313		22.00
	非绝缘开放式插塞型接头	HS202B	0.08 - 2.5 mm ²	22.00



Die set
钳口















Range of Application
应用范围

Item Code
型号





Crimping Range
压接范围 (mm²)

List Price 大价
(RM/pc)

套管式专用钳 (压后呈正四边形)

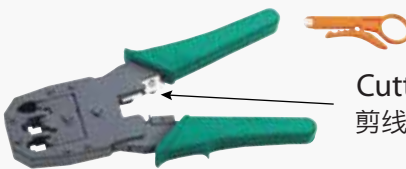
 <p>HSC8 6-4</p>  <p>HSC8 16-4</p>	 <p>绝缘/非绝缘欧式端子</p> 	<p>HSC86-4</p>	<p>0.25 - 6.0 mm²</p>	<p>82.00</p>
 <p>压力调节器 (Adjustable knob)</p>	 <p>(压后呈正四边形) Square shape crimp</p>	<p>HSC86-4C</p>	<p>0.25 - 10.0 mm²</p>	<p>110.00</p>
 <p>压力调节器 (Adjustable knob)</p>		<p>HSC916-4A</p>	<p>0.25 - 16.0 mm²</p>	<p>155.00</p>
	 	<p>HS05WF</p>	<p>0.5 - 6.0 mm²</p>	<p>65.00</p>
	 	<p>HS35WF</p>	<p>10, 16, 25, 35 mm²</p>	<p>70.00</p>
	  <p>(压后呈正六边形) Hexagonal shape crimp</p>	<p>HSC86-6A</p>	<p>0.25 - 6.0 mm²</p>	<p>100.00</p>

Telekom Tool (3-in-1) 电讯接头压接钳 (3合1)

 <p>Cutting, Stripping 剪线, 剥线</p>	<p>HT315</p>	 <p>RJ10 (4芯)</p>	<p>28.00</p>
 <p>Ratchet Type 棘轮式端子 压接钳省力型</p>	<p>HT2008R</p>	 <p>RJ11 (6芯)</p>  <p>RJ45 (8芯)</p>	<p>56.00</p>

Ratchet Cable Cutter 棘轮式电线剪



8"



10"



12"



14"



20"

VC30A	VC36A	VC60A	VSJ62A	VSJ80A
up to / 限制 240 mm ²	up to / 限制 300 mm ²	up to / 限制 500 mm ²	up to / 限制 800 mm ²	up to / 限制 1000 mm ²
N.A.	List Price RM402.00	List Price RM495.00	List Price RM950.00	List Price RM1,300.00

For cutting copper and aluminium single conductors as well as multiple stranded cables
 Not suitable for steel wire and wire ropes
 用以剪切铜铝电线，单股线和多股线。不可用于剪切钢丝，钢丝索及钢芯铝绞线

剥线工具

Wire Stripping Tools

Automatic Wire Stripper 自动剥线钳



Cutter & Wire Stripper 多功能电线剥皮钳



Fibre Optic Cable Cutter & Wire Stripper 光纤电线剥线钳



HS-D1	HS700B	HS700D	HS1041	FSA0625
List Price RM53.00	List Price RM36.00	List Price RM26.00	List Price RM14.00	List Price RM34.00

<p>Wire Stripping 剥线限制：0.25 - 6.0 mm²</p> <p>Wire Cutting 剪切限制：0.25 - 6.0 mm²</p> <p>Crimping terminal 压接端子：0.5 - 6.0 mm²</p>	<p>Wire Stripping 剥线限制：0.5 - 6.0 mm²</p> <p>Ø1.0, 1.6, 2.0, 2.6, 3.2mm</p> <p>Single Wire Core Wire</p>	<p>剪切, 压接两用</p> <p>Wire Stripping 剥线限制：0.25 - 6.0 mm²</p> <p>Wire Cutting 剪切限制：0.25 - 6.0 mm²</p>	<p>Wire Stripping 剥线限制：0.9 - 6.0 mm²</p> <p>Wire Cutting 剪切限制：≤16.0 mm²</p> <p>Crimping terminal 压接端子</p>	<p>Wire Stripping 剥线限制：0.2 - 2.4 mm²</p> <p>Wire Cutting 剪切电线限制：≤25.0 mm²</p>
--	---	---	---	---

CHISU
JAPAN

REX™













SHELL™

RONG YUNN
CRIMPING PLIBRO & CABLE CUTTERS

开孔器 / 导管工具

Type 款型	Range of Application 应用范围	Item Code 型号	Cutting Range 剪切范围 (mm ²)	List Price 大价 (RM/pc)
CHISU High Speed Steel Hole Cutter 高速钢镀镍开孔器				
	 <p>Hole Cutting 孔切铁板</p>	HC19	19mm	10.50
		HC20	20mm	11.50
		HC22	22mm	12.50
		HC25	25mm	14.50
		HC32	32mm	18.00
		HC38	38mm	21.00
		HC50	50mm	29.00
		HC-32-REX	32mm	14.00
		HC-38-REX	38mm	17.00

Pipe Tools 导管工具

	<p>No.1 Pipe Vice 1号管子台虎钳</p> 	<p>Item Code 型号</p> <p>HPV-1</p>	<p>Pipe size from : 导管外径 3/4" to 2"</p>	<p>List Price 大价 (RM/pc)</p> <p>76.00</p>
	<p>"SHELL" Conduit Dies Set "SHELL" 管子铰板</p> 	<p>JT4411PD</p>	<p>Spare Dies set 板牙套 19, 25, 31, 38 mm</p>	<p>178.00</p>
	<p>Spare Dies 板牙</p>	<p>SP19 SP25 SP31 SP38</p>	<p>Conduit pipe size : 导管外径 19mm 25mm 31mm 38mm</p>	<p>25.00 25.00 26.00 28.00</p>
	 <p>Twisted Pair Cable puller 电线管穿线工具 (15m)</p>	<p>TWP-15</p>	<p>Length : 长度 15 mt</p>	<p>40.00</p>
	 <p>PVC Pipe Bending Spring 弯管弹簧</p> <p>"SHELL" UK Flat type "SHELL" UK 平面 (黑)</p> 	<p>BS20 BS25</p>	<p>PVC pipe size : PVC管外径 20mm 25mm</p>	<p>9.50 12.50</p>
	 <p>PVC Pipe Cutter 塑料管剪切钳</p> <p>For cutting PVC pipes : 合适的切割范围 20 - 32 mm</p> 	<p>FYC101C</p>	<p>Tool length : 钳子长度 195mm / 8"</p>	<p>15.50</p>



Page 22 页

Page 23 页



Page 24 页

Page 25 页

Page 25 页



Page 23 页

Page 24 页

Page 28 页



Page 26 页

Page 24 页



Page 27 页

Page 28 页



CEE

Twisllok

NEM-CEE

防水插头/插座



3Pin Plug

2P + E



IP44

P013	P023
16A3Pin	32A3Pin
List Price RM7.00	List Price RM12.00

3Pin Wall Skt

2P + E



IP44

S113	S123
16A3Pin	32A3Pin
List Price RM11.00	List Price RM15.00

3Pin Coupler

2P + E



IP44

C213	C223
16A3Pin	32A3Pin
List Price RM8.80	List Price RM13.40

4Pin Plug

3P + E



IP44

P014	P024
16A4Pin	32A4Pin
List Price RM8.60	List Price RM13.50

4Pin Wall Skt

3P + E



IP44

S114	S124
16A4Pin	32A4Pin
List Price RM12.60	List Price RM15.60

4Pin Coupler

3P + E



IP44

C214	C224
16A4Pin	32A4Pin
List Price RM9.80	List Price RM14.00

5Pin Plug

3P + N + E



IP44

P015	P025
16A5Pin	32A5Pin
List Price RM10.80	List Price RM15.60

5Pin Wall Skt

3P + N + E



IP44

S115	S125
16A5Pin	32A5Pin
List Price RM14.80	List Price RM18.00

5Pin Coupler

3P + N + E



IP44

C215	C225
16A5Pin	32A5Pin
List Price RM13.00	List Price RM16.00

CEE 110V (4hr) 插头/插座 CEE Plug & Socket 110V 4-hr

3Pin Plug - 4hr

2P + E



IP44

P013-4
16A3Pin 4Hr (110V)
List Price RM8.00

3Pin Wall Skt - 4hr

2P + E



IP44

S113-4
16A3Pin 4Hr (110V)
List Price RM15.00

3Pin Coupler - 4hr

2P + E



IP44

C213-4	C223-4
16A (110V)	32A (110V)
List Price RM11.50	List Price RM17.00

NEM-CEE 防水插头 / 插座

 3Pin Plug		IP67	 3Pin Wall Skt		IP67	 3Pin Coupler		IP67
	P033	P043		S133	S143		C233	C243
	63A3Pin	125A3Pin		63A3Pin	125A3Pin		63A3Pin	125A3Pin
	List Price	N.A.		List Price	RM76.00		List Price	RM69.00
	RM50.00			List Price	RM199.00		List Price	RM190.00
 4Pin Plug		IP67	 4Pin Wall Skt		IP67	 4Pin Coupler		IP67
	P034	P044		S134	S144		C234	C244
	63A4Pin	125A4Pin		63A4Pin	125A4Pin		63A4Pin	125A4Pin
	List Price	RM54.00		List Price	RM78.00		List Price	RM72.00
	List Price	RM180.00		List Price	RM235.00		List Price	RM200.00
 5Pin Plug		IP67	 5Pin Wall Skt		IP67	 5Pin Coupler		IP67
	P035	P045		S135	S145		C235	C245
	63A5Pin	125A5Pin		63A5Pin	125A5Pin		63A5Pin	125A5Pin
	List Price	RM60.00		List Price	RM85.00		List Price	RM81.00
	List Price	RM190.00		List Price	RM250.00		List Price	RM235.00

NEM-CEE 防水插头 / 插座

CEE 多功能插头-插座 CEE Multi-way Plug & Socket

 IP44 3Pin 2-way		IP44	 IP44 3Pin 3-way		IP44	 IP44 4Pin 3-way		IP44
	PC1012	PC1022		PC1013	PC1023		PC1014	PC1024
	16A3Pin	32A3Pin		16A3Pin	32A3Pin		16A4Pin	32A4Pin
	List Price	RM39.00		List Price	RM48.00		List Price	RM68.00
	List Price	RM76.00		List Price	RM100.00		List Price	RM109.00

CEE Angle Panel Mounting Socket 暗装斜座

 2P + E 3Pin Panel Socket		IP44						
	<table border="1"> <tr> <td>FA313</td> <td>FA323</td> </tr> <tr> <td>16A3Pin</td> <td>32A3Pin</td> </tr> <tr> <td>List Price RM10.00</td> <td>List Price RM14.80</td> </tr> </table>	FA313	FA323	16A3Pin	32A3Pin	List Price RM10.00	List Price RM14.80	
	FA313	FA323						
16A3Pin	32A3Pin							
List Price RM10.00	List Price RM14.80							
 3P + E 4Pin Panel Socket		IP44						
	<table border="1"> <tr> <td>FA314</td> <td>FA324</td> </tr> <tr> <td>16A4Pin</td> <td>32A4Pin</td> </tr> <tr> <td>List Price RM13.00</td> <td>List Price RM17.00</td> </tr> </table>	FA314	FA324	16A4Pin	32A4Pin	List Price RM13.00	List Price RM17.00	
	FA314	FA324						
16A4Pin	32A4Pin							
List Price RM13.00	List Price RM17.00							
 3P + N + E 5Pin Panel Socket		IP44						
	<table border="1"> <tr> <td>FA315</td> <td>FA325</td> </tr> <tr> <td>16A5Pin</td> <td>32A5Pin</td> </tr> <tr> <td>List Price RM14.00</td> <td>List Price RM19.00</td> </tr> </table>	FA315	FA325	16A5Pin	32A5Pin	List Price RM14.00	List Price RM19.00	
	FA315	FA325						
16A5Pin	32A5Pin							
List Price RM14.00	List Price RM19.00							
 2P + E 3Pin Panel Socket - 4hr	110V (4hr) 	IP44						
	<table border="1"> <tr> <td>FA313-4</td> </tr> <tr> <td>16A3pin 4Hr (110V)</td> </tr> <tr> <td>List Price RM18.00</td> </tr> </table>	FA313-4	16A3pin 4Hr (110V)	List Price RM18.00				
	FA313-4							
16A3pin 4Hr (110V)								
List Price RM18.00								
 2P + E IP67 16A 3Pin 3-way		IP67						
	<table border="1"> <tr> <td>PC10132</td> </tr> <tr> <td>16A3Pin</td> </tr> <tr> <td>List Price RM86.00</td> </tr> </table>	PC10132	16A3Pin	List Price RM86.00				
	PC10132							
16A3Pin								
List Price RM86.00								
 3P + E IP67 32A 4Pin 3-way		IP67						
	<table border="1"> <tr> <td>PC10242</td> </tr> <tr> <td>32A4Pin</td> </tr> <tr> <td>List Price RM140.00</td> </tr> </table>	PC10242	32A4Pin	List Price RM140.00				
	PC10242							
32A4Pin								
List Price RM140.00								
 2P + E 3Pin Panel Socket		IP67						
	<table border="1"> <tr> <td>AJ3131</td> <td>AJ3232</td> </tr> <tr> <td>16A3Pin</td> <td>32A3Pin</td> </tr> <tr> <td>List Price RM21.00</td> <td>List Price RM29.00</td> </tr> </table>	AJ3131	AJ3232	16A3Pin	32A3Pin	List Price RM21.00	List Price RM29.00	
	AJ3131	AJ3232						
16A3Pin	32A3Pin							
List Price RM21.00	List Price RM29.00							
 3P + E 4Pin Panel Socket		IP67						
	<table border="1"> <tr> <td>AJ3142</td> <td>AJ3241</td> </tr> <tr> <td>16A4Pin</td> <td>32A4Pin</td> </tr> <tr> <td>List Price RM23.00</td> <td>List Price RM31.00</td> </tr> </table>	AJ3142	AJ3241	16A4Pin	32A4Pin	List Price RM23.00	List Price RM31.00	
	AJ3142	AJ3241						
16A4Pin	32A4Pin							
List Price RM23.00	List Price RM31.00							
 3P + N + E 5Pin Panel Socket		IP67						
	<table border="1"> <tr> <td>AJ3152</td> <td>AJ3251</td> </tr> <tr> <td>16A5Pin</td> <td>32A5Pin</td> </tr> <tr> <td>List Price RM25.00</td> <td>List Price RM40.00</td> </tr> </table>	AJ3152	AJ3251	16A5Pin	32A5Pin	List Price RM25.00	List Price RM40.00	
	AJ3152	AJ3251						
16A5Pin	32A5Pin							
List Price RM25.00	List Price RM40.00							
 2P + E 3Pin Panel Socket		IP67						
	<table border="1"> <tr> <td>FA333</td> <td>FA343</td> </tr> <tr> <td>63A3Pin</td> <td>125A3Pin</td> </tr> <tr> <td>List Price RM77.00</td> <td>List Price RM235.00</td> </tr> </table>	FA333	FA343	63A3Pin	125A3Pin	List Price RM77.00	List Price RM235.00	
	FA333	FA343						
63A3Pin	125A3Pin							
List Price RM77.00	List Price RM235.00							
 3P + E 4Pin Panel Socket		IP67						
	<table border="1"> <tr> <td>FA334</td> <td>FA344</td> </tr> <tr> <td>63A4Pin</td> <td>125A4Pin</td> </tr> <tr> <td>List Price RM85.00</td> <td>List Price RM245.00</td> </tr> </table>	FA334	FA344	63A4Pin	125A4Pin	List Price RM85.00	List Price RM245.00	
	FA334	FA344						
63A4Pin	125A4Pin							
List Price RM85.00	List Price RM245.00							
 3P + N + E 5Pin Panel Socket		IP67						
	<table border="1"> <tr> <td>FA335</td> <td>FA345</td> </tr> <tr> <td>63A5Pin</td> <td>125A5Pin</td> </tr> <tr> <td>List Price RM93.00</td> <td>List Price RM260.00</td> </tr> </table>	FA335	FA345	63A5Pin	125A5Pin	List Price RM93.00	List Price RM260.00	
	FA335	FA345						
63A5Pin	125A5Pin							
List Price RM93.00	List Price RM260.00							

NEM-CEE 暗装斜座 / 多功能插头-插座

CEE Panel Mounting Plug 暗装插头

2P + E 3Pin Panel Plug		IP44		
	FS613	FS623		
	16A3Pin	32A3Pin		
	List Price RM15.00	List Price RM21.00		
2P + E 3Pin Panel Plug		IP67		
	FS633	FS643		
	63A3Pin	125A3Pin		
	List Price RM86.00	List Price RM205.00		
3P + E 4Pin Panel Plug		IP44		
	FS614	FS624		
	16A4Pin	32A4Pin		
	List Price RM17.00	List Price RM23.00		
3P + E 4Pin Panel Plug		IP67		
	FS634	FS644		
	63A4Pin	125A4Pin		
	List Price RM90.00	List Price RM215.00		
3P + N + E 5Pin Panel Plug		IP44		
	FS615	FS625		
	16A5Pin	32A5Pin		
	List Price RM20.50	List Price RM24.50		
3P + N + E 5Pin Panel Plug		IP67		
	FS635	FS645		
	63A5Pin	125A5Pin		
	List Price RM95.00	List Price RM230.00		

CEE Surface Wall Plug 明装插头

2P + E 3Pin Surface Plug		IP44		
	WP513	WP523		
	16A3Pin	32A3Pin		
	List Price RM18.00	List Price RM24.00		
2P + E 3Pin Surface Plug		IP67		
	WP533	WP543		
	63A3Pin	125A3Pin		
	List Price RM98.00	List Price RM215.00		
3P + E 4Pin Surface Plug		IP44		
	WP514	WP524		
	16A4Pin	32A4Pin		
	List Price RM20.00	List Price RM26.00		
3P + E 4Pin Surface Plug		IP67		
	WP534	WP544		
	63A4Pin	125A4Pin		
	List Price RM105.00	List Price RM225.00		
3P + N + E 5Pin Surface Plug		IP44		
	WP515	WP525		
	16A5Pin	32A5Pin		
	List Price RM22.00	List Price RM28.00		
3P + N + E 5Pin Surface Plug		IP67		
	WP535	WP545		
	63A5Pin	125A5Pin		
	List Price RM108.00	List Price RM245.00		

3Pin Plug  2P + E



IP67

TP0132	TP0232
16A3Pin	32A3Pin
List Price RM12.00	List Price RM19.00

3Pin Wall Skt  2P + E



IP67

TS1132	TS1232
16A3Pin	32A3Pin
List Price RM20.00	List Price RM28.00

3Pin Coupler  2P + E



IP67

TC2132	TC2232
16A3Pin	32A3Pin
List Price RM16.00	List Price RM22.00

4Pin Plug  3P + E



IP67

TP0142	TP0242
16A4Pin	32A4Pin
List Price RM14.50	List Price RM22.00

4Pin Wall Skt  3P + E



IP67

TS1142	TS1242
16A4Pin	32A4Pin
List Price RM23.50	List Price RM30.00

4Pin Coupler  3P + E



IP67

TC2142	TC2242
16A4Pin	32A4Pin
List Price RM17.00	List Price RM24.00

5Pin Plug  3P + N + E



IP67

TP0152	TP0252
16A5Pin	32A5Pin
List Price RM17.00	List Price RM27.00

5Pin Wall Skt  3P + N + E



IP67

TS1152	TS1252
16A5Pin	32A5Pin
List Price RM26.00	List Price RM33.00

5Pin Coupler  3P + N + E



IP67

TC2152	TC2252
16A5Pin	32A5Pin
List Price RM20.00	List Price RM27.00

冷藏货柜防水插头/插座

Plug & Socket for Reefer Container (32A 4pin 3-hr)

4Pin Plug - 3hr  3P + E



IP67

TP0242-3
32A4pin 3Hr
List Price RM33.00

4Pin Wall Skt - 3hr  3P + E



IP67

TS1242-3
32A4pin 3Hr
List Price RM47.00

4Pin Coupler - 3hr  3P + E



IP67

TC2242-3
32A4pin 3Hr
List Price RM37.00

TWISLOK (IP67) 防水插头 - 插座 - 第一代



 2P + E 3Pin Plug		IP67	 2P + E 3Pin Wall Skt		IP67	 2P + E 3Pin Coupler		IP67									
	AJ0131	AJ0231		AJ1131	AJ1231		AJ2131	AJ2231									
	16A3Pin	32A3Pin		16A3Pin	32A3Pin		16A3Pin	32A3Pin									
	List Price	RM16.00		List Price	RM24.00		List Price	RM19.00		List Price	RM25.00		List Price	RM37.00		List Price	RM27.00
 3P + E 4Pin Plug		IP67	 3P + E 4Pin Wall Skt		IP67	 3P + E 4Pin Coupler		IP67									
	AJ0141	AJ0241		AJ1141	AJ1241		AJ2141	AJ2241									
	16A4Pin	32A4Pin		16A4Pin	32A4Pin		16A4Pin	32A4Pin									
	List Price	RM18.00		List Price	RM26.50		List Price	RM21.00		List Price	RM27.00		List Price	RM38.00		List Price	RM32.00
 3P + N + E 5Pin Plug		IP67	 3P + N + E 5Pin Wall Skt		IP67	 3P + N + E 5Pin Coupler		IP67									
	AJ0151	AJ0251		AJ1151	AJ1251		AJ2151	AJ2251									
	16A5Pin	32A5Pin		16A5Pin	32A5Pin		16A5Pin	32A5Pin									
	List Price	RM21.00		List Price	RM30.00		List Price	RM26.00		List Price	RM32.00		List Price	RM42.00		List Price	RM36.00

冷藏货柜防水插头/插座

Plug & Socket for Reefer Container (32A 4pin 3-hr)

 3P + E 4Pin Plug - 3hr		IP67	 3P + E 4Pin Wall Skt - 3hr		IP67	 3P + E 4Pin Coupler - 3hr		IP67
	AJ0241-3	AJ1241-3		AJ2241-3				
	32A4pin 3Hr	32A4pin 3Hr		32A4pin 3Hr				
	List Price	RM36.00		List Price	RM50.00		List Price	RM41.00

3Pin Plug  2P + E



IP67

AJ0332
63A3Pin
List Price RM75.00

3Pin Wall Skt  2P + E



IP67

AJ1332
63A3Pin
List Price RM112.00

3Pin Coupler  2P + E



IP67

AJ2332
63A3Pin
List Price RM108.00

4Pin Plug  3P + E



IP67

AJ0342	AJ0442
63A4Pin	125A4Pin
List Price RM80.00	List Price RM290.00

4Pin Wall Skt  3P + E



IP67

AJ1342	AJ1442
63A4Pin	125A4Pin
List Price RM125.00	List Price RM375.00

4Pin Coupler  3P + E



IP67

AJ2342	AJ2442
63A4Pin	125A4Pin
List Price RM110.00	List Price RM345.00

5Pin Plug  3P + N + E



IP67

AJ0352	AJ0452
63A5Pin	125A5Pin
List Price RM92.00	List Price RM310.00

5Pin Wall Skt  3P + N + E



IP67

AJ1352	AJ1452
63A5Pin	125A5Pin
List Price RM135.00	List Price RM380.00

5Pin Coupler  3P + N + E



IP67

AJ2352	AJ2452
63A5Pin	125A5Pin
List Price RM128.00	List Price RM350.00

IP67 16A 3Pin 3-way  2P + E



MCB & ELCB **16A 3 pin IP67**

Combination Socket Box

IP67

组合插座箱 IP67



Model	A05M-6-IP67-3C
Plug & Socket	16A3pin IP67
MCB & ELCB	3pcs x 16A 1Pole MCB / 1pc x 40A 2P 0.03A ELCB
List Price	RM420.00

TWISLOK (IP67) GEN2
防水插头 - 插座
IP67 第二代



Page 30 页

Page 30 页



Page 31 页

Page 31 页



Page 32 页

Page 32 页

Page 32 页



Page 33 页

Page 33 页

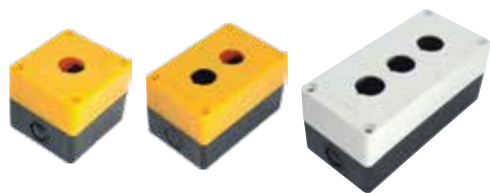

Page 33 页



Page 33 页

TMazTZ®

CHIKAMATSU™

				
TZ8104	TZ8108	TZ8108-M12	TZ8107	TZ8111
List Price RM26.00	List Price RM26.00	List Price RM26.00	List Price RM24.00	List Price RM21.00
				
TZ8112	TZ8122	TZ8166	TZ8167	TZ8169
List Price RM21.00	List Price RM21.00	List Price RM21.00	List Price RM21.00	List Price RM21.00

微动开关

Mini Micro Switches

					
V15 (MV3000)	V151 (MV3002)	V152 (MV3003)	V154 (MV3001)	V155 (MV3004)	V156 (MV3005)
List Price RM4.20	List Price RM4.20	List Price RM4.20	List Price RM4.20	List Price RM4.20	List Price RM4.20

小型横式限位开关

Mini Enclosed Limit Switches

模块交流接触器

Modular Contactor 63A

				
TZ7310	TZ7311	TZ7121	MC632 2 Pole (2 N/O)	MC634 4 Pole (4 N/O)
List Price RM16.00	List Price RM16.00	List Price RM16.00	List Price RM63.00	List Price RM85.00



WLD (7101)

List Price RM52.00



WLD1 (7102-N)

List Price RM52.00



WLD2 (7102)

List Price RM52.00



WLD3 (7103)

List Price RM57.00



WLCA2-2 (7204)

List Price RM57.00



WLCL (7107)

List Price RM57.00



WLCA12-2-Q (7208)

List Price RM57.00



WLCA32-41 (3241)

List Price RM65.00



WLNJ (7106)

List Price RM52.00

微动开关

Micro Switches



TM1306

List Price RM10.00



TM1307

List Price RM11.50



TM1308

List Price RM12.70



TM1309

List Price RM12.70



CH1300

List Price RM9.00



TM1701

List Price RM10.00



TM1702

List Price RM10.00



TM1703

List Price RM10.00



TM1704

List Price RM10.00



TAP-Y

List Price RM2.20

Pushbutton Flat Head 平头按钮				
	AR22A01R	AR22A11R	AR22A10G	AR22A11G
	1N/C	1N/O + 1N/C	1N/O	1N/O + 1N/C
	List Price RM6.20	List Price RM9.40	List Price RM6.20	List Price RM9.40

Other colour caps 其他盖子颜色		1N/O	1N/O + 1N/C
		AR22A10Y	AR22A11Y
		AR22A10S	AR22A11S
		AR22A10B	AR22A11B
		AR22A10W	AR22A11W
		List Price RM6.20	List Price RM9.40

Illuminated LED 带灯按钮				
	AR22TP01R	AR22TP11R	AR22TP10G	AR22TP11G
	1N/C	1N/O + 1N/C	1N/O	1N/O + 1N/C
	List Price RM14.80	List Price RM18.00	List Price RM14.80	List Price RM18.00

Other colour caps 其他盖子颜色		1N/O	1N/O + 1N/C
		AR22TP10Y	AR22TP11Y
		AR22TP10S	AR22TP11S
		List Price RM14.80	List Price RM18.00

**Illuminated LED Pushbutton is available in AC240V & DC24V **带灯LED按钮提供两种电压 AC240V & DC24V

Alternate Illuminated 带灯压锁按钮				
	AR22TPS01R	AR22TPS11R	AR22TPS10G	AR22TPS11G
	1N/C	1N/O + 1N/C	1N/O	1N/O + 1N/C
	List Price RM17.80	List Price RM21.00	List Price RM17.80	List Price RM21.00

Other colour caps 其他盖子颜色		1N/O	1N/O + 1N/C
		AR22TPS10Y	AR22TPS11Y
		AR22TPS10S	AR22TPS11S
		List Price RM17.80	List Price RM21.00

Mushroom Button 40mm 蘑菇头按钮				
	AR22M01R	AR22M11R	AR22M10G	AR22M11G
	1N/C	1N/O + 1N/C	1N/O	1N/O + 1N/C
	List Price RM7.50	List Price RM10.70	List Price RM7.50	List Price RM10.70

Other colour caps 其他盖子颜色		AR22M10Y	AR22M11Y
		1N/O	1N/O + 1N/C
		List Price RM7.50	List Price RM10.70

Emergency Reset 紧急停止按钮		
	AR22ER01	AR22ER11R
	1N/C	1N/O + 1N/C
	List Price RM13.00	List Price RM16.20

Push Reset
(EMERGENCY STOP)
紧急停止按钮



22mm Pilot Lamp 面板指示灯		AR229ER	AR229EW
		AR229EG	
		AR229ES	
		AR229EY	
		List Price RM5.15	List Price RM5.15

On-Off Selector 选择开关			On-Off-On			On-Off Key Selector 选择钥匙开关			On-Off-On					
	AR22N210	AR22N211		AR22N320	AR22K210		AR22K211	AR22K320						
	1N/O	1N/O + 1N/C		2N/O	1N/O		1N/O + 1 N/C	2N/O						
	List Price RM9.20	List Price RM12.40		List Price RM12.40		List Price RM15.80	List Price RM19.00		List Price RM19.00					
On-Off Selector 选择开关			On-Off-On			On-Off Key Selector 选择钥匙开关			On-Off-On					
	CCB-N210	CCB-N211		CCB-N320	CCB-K210		CCB-K211	CCB-K320						
	1N/O	1N/O + 1N/C		2N/O	1N/O		1N/O + 1N/C	2N/O						
	List Price RM13.20	List Price RM16.40		List Price RM16.40		List Price RM19.80	List Price RM23.00		List Price RM23.00					
Pushbutton Flat Head 平头按钮					Emergency Reset 紧急停止按钮									
	CCB-A01R	CCB-A11R	CCB-A10G	CCB-A11G		CCB-ER01	CCB-ER11							
	1N/C	1N/O + 1N/C	1N/O	1N/O + 1N/C		1N/C	1N/O + 1N/C							
	List Price RM10.20	List Price RM13.40	List Price RM10.20	List Price RM13.40	List Price RM17.00	List Price RM20.20								
Control Box 防水按钮盒					Contact Block 触头 常开 / 常闭									
	CB-1H	CB-2H	CB-3H	CB-4H		HR10	HR01							
	List Price RM3.80	List Price RM4.60	List Price RM5.80	List Price RM7.80		N/O	N/C							
	List Price RM3.20	List Price RM3.20												
Accessories 按钮配件														
	RT-1	RT-111	HLW29911	APW199	PB22	PB25	ER30							
	Name Plate 12 X 25 mm	Emergency Stop Sticker (紧急停止标贴)	Neon Pushbutton	Neon Pilot Lamp	22mm "STOP"	25mm Pusbutton	30mm Push Reset							
	List Price RM1.10	List Price RM1.30	List Price RM11.50	List Price RM2.70	List Price RM1.20	List Price RM2.50	List Price RM4.00							



灯泡转灯

Page 35 页



LED频闪

Page 35 页



Page 35 页



Page 36 页







































Page 36 页

NANZHOU 南洲

WARNING DEVICES

警示灯 / 警报器 / 警铃

LTE1101 4" 4" Bulb type 螺栓固定式	  灯泡转灯	AC240 & AC110 & DC12 & DC24 (R/Y/B/G)	List Price RM25.00	LTE5101 4" LED 4" LED FLASH type 螺栓固定式	  LED频闪	AC240 & AC110 & DC12 & DC24 (R/Y/B/G)	List Price RM64.00								
	List Price RM25.00		List Price RM64.00												
LTE1101J 4" 4" w/Buzzer (90dB) 带蜂鸣器	  灯泡转灯	AC240 & DC12 & DC24 (R/Y/B/G)	List Price RM35.00	LTE5101J 4" LED 4" w/Buzzer (90dB) 带蜂鸣器	  LED频闪	AC240 & DC12 & DC24 (R/Y/B/G)	List Price RM73.00								
	List Price RM35.00		List Price RM73.00												
LTD1101 4" 4" w/Magnet 磁吸式	  灯泡转灯	DC12 & DC24 (R/Y/B/G)	List Price RM37.00	LTD5101 4" LED 4" w/Magnet 磁吸式	  LED频闪	DC12 & DC24 (R/Y/B/G)	List Price RM78.00								
	List Price RM37.00		List Price RM78.00												
LTE1161 6" 6" Bulb type 螺栓固定式	  灯泡转灯	AC240 & DC12 & DC24 (R/Y/B/G)	List Price RM67.00	LTE5161 6" LED 6" LED FLASH type 螺栓固定式	  LED频闪	AC240 (R/Y/B/G) DC24 (RED Only)	List Price RM103.00								
	List Price RM67.00		List Price RM103.00												
LTD1201 Bulb type w/Magnet 磁吸式	  灯泡转灯	DC12 & DC24 (R/Y/B/G)	List Price RM60.00	Accessories 配件	  	<table border="1"> <thead> <tr> <th>Filament</th> <th>Halogen</th> <th>4" Cover</th> </tr> </thead> <tbody> <tr> <td>for 4"</td> <td>for 6"</td> <td>● ● ● ●</td> </tr> <tr> <td>List Price RM3.50</td> <td>List Price RM6.50</td> <td>List Price RM8.00</td> </tr> </tbody> </table>	Filament	Halogen	4" Cover	for 4"	for 6"	● ● ● ●	List Price RM3.50	List Price RM6.50	List Price RM8.00
	Filament	Halogen	4" Cover												
for 4"	for 6"	● ● ● ●													
List Price RM3.50	List Price RM6.50	List Price RM8.00													
List Price RM60.00		List Price RM3.50 List Price RM6.50 List Price RM8.00													

MS190		2.5" Baby Mini Siren	MS290		4" Motor Siren (Metal)	MS390		4" Motor Siren	
	<i>AC240 & AC110 & DC12 & DC24</i>			<i>AC240 & AC110 & DC12 & DC24</i>			<i>AC240</i>		
	List Price RM32.00			List Price RM55.00			List Price RM130.00		
MS490		4 1/2" Siren AC240	MS590		6" Siren AC240	MS690		8" Siren AC240	
	List Price RM381.00			List Price RM750.00			List Price RM1500.00		
MS790		10" Siren AC240							
	List Price RM1750.00								
CB4B		4" Alarm Bell	CB6B		6" Alarm Bell	CB8B-R		8" Alarm Bell	
	<i>AC240 & DC12 & DC24</i>			<i>AC240 & DC12 & DC24</i>			<i>AC240 & DC24</i>		
	List Price RM49.00			List Price RM62.00			List Price RM65.00		
CB8B-G		8" Alarm Bell					Grey 灰		
	<i>AC240 & DC24</i>						<i>AC240 & DC24</i>		
	List Price RM65.00						List Price RM65.00		
CB10B-R		10" Alarm Bell	CB10B-G		10" Alarm Bell				
	<i>AC240</i>			<i>AC240</i>				Grey 灰	
	List Price RM78.00			List Price RM78.00					
N80		3" Surface Buzzer	P80		3" Panel Buzzer	P30		1.5" Panel Buzzer	
	<i>AC240</i>			<i>AC110 & DC12 & DC24</i>			<i>AC240</i>		
	List Price RM11.50			List Price RM11.50			List Price RM11.50		

Index 指数



Page 38 页



Page 39 页



Page 41 页



Page 42 页



Page 44 页



Page 44 页



Page 45 页



Page 45 页



Page 46 页



Page 44 页



Page 38 页



Page 39 页



Page 39 页



Page 41 页



Page 42 页



Page 44 页



Page 40 页



Page 44 页



Page 45 页



Page 46 页



Page 46 页



Page 46 页



Page 38 页



Page 40 页



Page 43 页



Page 44 页



Page 46 页



UNI-T VICTOR WINAPEX

优利德 胜利仪器 汉研仪器

UNI-T®

VICTOR®

WINAPEX

i-POOK

BENETECH

 <p>NCV 非接触电压探测</p> <p>1999</p> <p>Auto Range 自动量程</p> <p>1.5V/9V/12V</p> <p>UNI-T® UT33D+</p> <p>List Price RM68.00</p>	 <p>AC/DC</p> <p>1999</p> <p>UNI-T® UT33A+</p> <p>List Price RM99.00</p>	 <p>1999</p> <p>UNI-T® UT33B+</p> <p>List Price RM72.00</p>	 <p>VoltAlert 防水型测电笔</p> <p>UNI-T® UT12D</p> <p>List Price RM35.00</p>	 <p>Digital VoltStick 防水型测电笔</p> <p>UNI-T® UT15C</p> <p>List Price RM200.00</p>
--	---	--	---	--

 <p>TRUE RMS 真有效值</p> <p>NCV 非接触电压探测</p> <p>0.00</p> <p>Flashlight</p> <p>VICTOR® VC202</p> <p>List Price RM64.00</p>	 <p>TRUE RMS 真有效值</p> <p>NCV 非接触电压探测</p> <p>1888</p> <p>Flashlight</p> <p>VICTOR® VC38D</p> <p>List Price RM68.00</p>	 <p>TRUE RMS 真有效值</p> <p>NCV 非接触电压探测</p> <p>0.00</p> <p>Flashlight</p> <p>VICTOR® VC203</p> <p>List Price RM78.00</p>	 <p>TRUE RMS 真有效值</p> <p>NCV 非接触电压探测</p> <p>°C/F 温度测量</p> <p>0.0000</p> <p>Flashlight</p> <p>VICTOR® VC97</p> <p>List Price RM210.00</p>	 <p>Auto Range 自动量程</p> <p>TRUE RMS 真有效值</p> <p>NCV 非接触电压探测</p> <p>0.0000</p> <p>Flashlight</p> <p>VICTOR® VC85D</p> <p>List Price RM110.00</p>
--	---	---	---	---

 <p>AC/DC</p> <p>TRUE RMS 真有效值</p> <p>NCV 非接触电压探测</p> <p>0.0000</p> <p>Flashlight</p> <p>Auto Range 自动量程</p> <p>WinAPEX HY108E</p> <p>List Price RM108.00</p>	 <p>AC/DC</p> <p>TRUE RMS 真有效值</p> <p>NCV 非接触电压探测</p> <p>0.0000</p> <p>Flashlight</p> <p>Auto Range 自动量程</p> <p>WinAPEX ET8101</p> <p>List Price RM82.00</p>	 <p>AC/DC</p> <p>TRUE RMS 真有效值</p> <p>NCV 非接触电压探测</p> <p>0.0000</p> <p>Flashlight</p> <p>Auto Range 自动量程</p> <p>WinAPEX ET8102</p> <p>List Price RM100.00</p>	 <p>VICTOR® VC10S</p> <p>List Price RM30.00</p>	 <p>VICTOR® VC11S</p> <p>List Price RM35.00</p>
---	---	--	---	--

NOTE : Please scan the QR code for more detailed specifications
 注意：详细规格请扫描二维码

UNI-T VICTOR WinAPEX

优利德 胜利仪器 汉研仪器

Capacitance & Inductance Meter 电感电容表	<ul style="list-style-type: none"> 电容 (F) 电阻 hFE 	<ul style="list-style-type: none"> 电感 电容 (F) 电阻 hFE 	<ul style="list-style-type: none"> 电容 (F) 	<ul style="list-style-type: none"> 电感 电容 (F)
	UNI-T® UT601	UNI-T® UT603	VICTOR® VC6013	VICTOR® VC6243
	List Price RM195.00	List Price RM285.00	List Price RM215.00	List Price RM290.00

<ul style="list-style-type: none"> AC/DC TRUE RMS 真有效值 NCV 非接触电压探测 电容 (F) Hz hFE Auto Range 自动量程 	<ul style="list-style-type: none"> AC/DC TRUE RMS 真有效值 NCV 非接触电压探测 电容 (F) Hz °C/F 温度测量 Auto Range 自动量程 	<ul style="list-style-type: none"> AC/DC TRUE RMS 真有效值 NCV 非接触电压探测 电容 (F) °C/F 温度测量 Flashlight 	<ul style="list-style-type: none"> AC/DC TRUE RMS 真有效值 电容 (F) hFE
UNI-T® UT61E+	VICTOR® VC86E	VICTOR® VC890C+	VICTOR® VC9806+
List Price RM610.00	List Price RM422.00	List Price RM145.00	List Price RM308.00

Pen type Digital Multimeter 笔型数字仪表	<ul style="list-style-type: none"> AC/DC TRUE RMS 真有效值 NCV 非接触电压探测 电容 (F) LIVE 零火线测量 Flashlight 	Analogue Multimeter 指针万用表			
	VICTOR® VC6012A		VICTOR® VC3021	VICTOR® VC7001	samwa YX360TRN
List Price RM139.00	List Price RM93.00	List Price RM55.00	List Price RM42.00		

NOTE : Please scan the QR code for more detailed specifications
 注意：详细规格请扫描二维码



Auto Range
自动量程

VICTOR® VC921	Ruoshui 921	VICTOR® VC922	VICTOR® VC923E
List Price RM74.00	List Price RM66.00	List Price RM89.00	List Price RM185.00



Auto Range
自动量程

Phase Sequence
相序表

VICTOR® VC923A	VICTOR® VC923C (COLOUR 彩屏)	WinAPEX ET8908	WinAPEX ET8909 Voice Broadcast
List Price RM128.00	List Price RM162.00	List Price RM99.00	List Price RM116.00













Auto Range
自动量程

Auto Range
自动量程

WinAPEX ET8136	WinAPEX ET8138 (COLOUR 彩屏)	WinAPEX ET8198DE Voice Control/Broadcast
List Price RM115.00	List Price RM145.00	List Price RM225.00

NOTE : Please scan the QR code for more detailed specifications
注意：详细规格请扫描二维码

Insulation Resistance Testers 绝缘电阻测试仪 - (1000V)			
	UNI-T® UT501A (1000V) 	UNI-T® UT501C (1000V) 	VICTOR® VC60B+ (1000V) 
List Price RM370.00		List Price RM335.00	
Insulation Resistance Testers 绝缘电阻测试仪 - (2500V)			
	UNI-T® UT502A (2500V) 	UNI-T® UT502C (2500V) 	VICTOR® VC60D+ (2500V) 
List Price RM680.00		List Price RM480.00	
Digital RCD (ELCB) Testers 漏电开关测试仪		Power Meter Socket 多功能计量插座电测量测  Amp, Power Factor, Hz, Watt, kWh, CO2 DEBUY PMS2210Y	
	UNI-T® UT582+ 		VICTOR® VC60E+ (5000V) 
List Price RM725.00		List Price RM880.00	
Digital Earth Testers 接地电阻测试仪			
	VICTOR® VC4105A 	UNI-T® UT521 	VICTOR® VC6310B 
List Price RM625.00		List Price RM1,460.00	
		DC Resistance Tester (micro-Ohm) 低电阻测试仪 (微欧计)	$\mu\Omega$ 电阻

NOTE : Please scan the QR code for more detailed specifications
注意 : 详细规格请扫描二维码

UNI-T®

VICTOR®

WinAPEX®

数字钳形 仪表



UNI-T® UT202A+	UNI-T® UT202+	UNI-T® UT203+	UNI-T® UT204+	UNI-T® UT204A
List Price RM135.00	List Price RM155.00	List Price RM278.00	List Price RM320.00	List Price RM260.00



VICTOR® VC606A	VICTOR® VC606B	VICTOR® VC606C	VICTOR® VC606E	VICTOR® VC606D
List Price RM115.00	List Price RM128.00	List Price RM225.00	List Price RM228.00	List Price RM140.00



VICTOR® VC606A+	VICTOR® VC606B+	VICTOR® VC606C+	WinAPEX® ET8203	WinAPEX® ET8202
List Price RM125.00	List Price RM138.00	List Price RM235.00	List Price RM172.00	List Price RM118.00

NOTE : Please scan the QR code for more detailed specifications
 注意：详细规格请扫描二维码

UNI-T
VICTOR
WinAPEX

优利德
胜利仪器
汉研仪器

<p>TRUE RMS 真有效值</p> <p>1000V</p> <p>°C/F 温度测量</p> <p>AC/DC 真有效值</p> <p>NCV 非接触电压探测</p> <p>电容 (F)</p> <p>Flashlight</p> <p>Auto Range 自动量程</p>	<p>TRUE RMS 真有效值</p> <p>NCV 非接触电压探测</p> <p>电容 (F)</p> <p>Flashlight</p> <p>Auto Range 自动量程</p>	<p>1000V</p> <p>°C/F 温度测量</p> <p>AC/DC 真有效值</p> <p>NCV 非接触电压探测</p> <p>电容 (F)</p> <p>Flashlight</p> <p>LIVE 零火线测量</p> <p>Auto Range 自动量程</p>	<p>1000V</p> <p>°C/F 温度测量</p> <p>TRUE RMS 真有效值</p> <p>NCV 非接触电压探测</p> <p>电容 (F)</p> <p>Flashlight</p> <p>Auto Range 自动量程</p>	<p>1000V</p> <p>°C/F 温度测量</p> <p>TRUE RMS 真有效值</p> <p>NCV 非接触电压探测</p> <p>电容 (F)</p> <p>Flashlight</p> <p>Auto Range 自动量程</p>
--	--	---	--	--

VICTOR® VC6016B+	WinAPEX ET8201	WinAPEX ET8204	VICTOR® VC608	VICTOR® VC606G
List Price RM105.00	List Price RM135.00	List Price RM195.00	List Price RM163.00	List Price RM130.00

AC/DC 1000A 钳形表	<p>AC/DC 1000A</p> <p>°C/F 温度测量</p> <p>电容 (F)</p> <p>Hz</p>	<p>AC/DC 1000A</p> <p>TRUE RMS 真有效值</p> <p>NCV 非接触电压探测</p> <p>电容 (F)</p> <p>°C/F 温度测量</p> <p>Hz</p>	<p>AC/DC 1000A</p> <p>TRUE RMS 真有效值</p> <p>NCV 非接触电压探测</p> <p>电容 (F)</p> <p>Hz</p>	<p>AC/DC 1000A</p> <p>TRUE RMS 真有效值</p> <p>NCV 非接触电压探测</p> <p>电容 (F)</p> <p>Hz</p> <p>°C/F 温度测量</p> <p>Auto Range 自动量程</p>
-----------------	---	---	--	--

UNI-T. UT208A	UNI-T. UT208B	UNI-T. UT207B	VICTOR® VC3288
List Price RM600.00	List Price RM665.00	List Price RM530.00	List Price RM254.00

Earth Clamp Testers / Leakage Current
钳形接地电阻 / 泄漏电流 测试仪

电阻

UNI-T. UT275+

List Price RM2,700.00

Flexible Clamp Sensor (3000A)
柔性线圈大电流钳表

UNI-T. CS09D

List Price RM450.00

Flexible Coil Large Current Leakage Clamp Meter
柔性线圈大电流漏电钳表

VICTOR® VC690

List Price RM555.00

NOTE : Please scan the QR code for more detailed specifications
注意 : 详细规格请扫描二维码

Pocket type 口袋钳形表



AC/DC
TRUE RMS
非接触电压探测
电容 (F)
Hz
°C/F
温度测量



AC/DC
TRUE RMS
非接触电压探测
电容 (F)
NCV
非接触电压探测



TRUE RMS
非接触电压探测
电容 (F)
°C/F
温度测量

Auto Range
自动量程



DC
TRUE RMS
非接触电压探测
电容 (F)
°C/F
温度测量
NCV
非接触电压探测

Auto Range
自动量程

LIVE
零火线测量



UNI-T UT210D

List Price RM330.00

UNI-T UT210E

List Price RM320.00

VICTOR VC6019A

List Price RM136.00

VICTOR VC6019C

List Price RM308.00



For Body Temperature
人体测温仪



UNI-T UT300A+

-20 to 400 °C

List Price RM90.00

VICTOR VC303B

-20 to 550 °C

List Price RM105.00

VC304A

-50 to 480 °C

List Price RM88.00

VC304B

-50 to 680 °C

List Price RM118.00

VC304C

-50 to 880 °C

List Price RM149.00

NITIKA HT880D

32 to 42.5 °C

List Price RM65.00



WinAPEX ET6531C

-50 to 600 °C

List Price RM118.00

WinAPEX ET6532

-50 to 600 °C

List Price RM84.00

1000 °C & Above
1000 °C 以上红外线测温仪



VICTOR VC308D

-50 to 1150 °C

List Price RM750.00



GM1150

-30 to 1150 °C

List Price RM405.00

UNI-T®
TEST PROBE

HC50



List Price RM10.00

NOTE : Please scan the QR code for more detailed specifications

注意：详细规格请扫描二维码

UNI-T VICTOR WINAPEX

优利德 胜利仪器 汉研仪器

Laser Distance Meter 激光测距仪	40M 40米	50M 50米	70M 70米	100M 100米	40m 米
					
	UNI-T. LM40	UNI-T. LM50A	UNI-T. LM70A	UNI-T. LM100A	VICTOR[®] VC841A
	List Price RM150.00	List Price RM155.00	List Price RM210.00	List Price RM270.00	List Price RM145.00

Laser Distance Meter 激光测距仪	Temperature/Humidity 迷你温湿度计	Tachometer 数字转速表
-------------------------------	-----------------------------	------------------

60m 米			Contact-type 接触式	Contact & Non-Contact-type 两用：接触 & 非接触
				
VICTOR[®] VC841B	UNI-T. UT333	UNI-T. UT320A	VICTOR[®] VC6235P	VICTOR[®] VC6236P
List Price RM200.00	List Price RM115.00	List Price RM110.00	List Price RM155.00	List Price RM225.00

Tachometer (Laser) 非接触式转速计(激光)			Illuminometer (Lux meter) 照度计			
	UNI-T. UT371	UNI-T. UT373		UNI-T. UT381	UNI-T. UT383	VICTOR[®] VC1010C
	List Price RM435.00	List Price RM123.00		List Price RM320.00	List Price RM110.00	List Price RM110.00

NOTE : Please scan the QR code for more detailed specifications
 注意：详细规格请扫描二维码

Wire Tracking Meters 电缆探测仪

Wall Scanner
墙体探测仪



VC7501



VC518

Underground Cable tracker
地下电缆故障, 管线,
电缆走向检测仪



Data cable Tracker
数字无噪音寻线仪



Network Tester
网络测试仪
RJ45/Cat5/6



VICTOR® VC518

List Price RM362.00

VICTOR® VC7501

List Price RM1,175.00

BENETECH® GM60

List Price RM130.00

VICTOR® VC468

List Price RM24.00

Wall Scanner
墙体探测仪



Anemometer
数字式风速仪



Anemometer
数字式风速仪



Anemometer
数字式风速仪



UNI-T® UT387C

List Price RM255.00

VICTOR® VC816B

List Price RM345.00

VICTOR® VC816

List Price RM113.00

UNI-T® UT363

List Price RM110.00

Coating Thickness
Gauge
漆膜仪涂层测厚仪



Vibration Meter
测振仪



Hygrometer
木材水份测试仪



Sound Level Meter
迷你噪音计



3 Phase Indicator
三相交流电相序计

VICTOR® VC852B

List Price RM690.00

VICTOR® VC63D

List Price RM2,050.00

VICTOR® VC2GA

List Price RM145.00

BENETECH® GM1351

List Price RM103.00

VICTOR® VC850A

List Price RM98.00

NOTE : Please scan the QR code for more detailed specifications
注意：详细规格请扫描二维码

UNI-T VICTOR BENETECH

优利德 胜利仪器 标智



Page 48 页



Page 48 页



Page 48 页



Page 49 页



Page 49 页



Page 50 页



Page 50 页



Page 50 页



Using
MK
Switches



Using
MK
Switches



Page 51 页





2P + E



2P + E



3P + E



3P + E



3P + N + E



3P + N + E

16A3Pin	32A3Pin	16A4Pin	32A4Pin	16A5Pin	32A5Pin
67CEE316	67CEE332	67CEE416	67CEE432	67CEE516	67CEE532
List Price RM92.00	List Price RM108.00	List Price RM98.00	List Price RM118.00	List Price RM108.00	List Price RM130.00



2P + E



3P + E



3P + E



3P + N + E

16A3Pin
R67CEE316
List Price RM145.00

16A4Pin
R67CEE416
List Price RM160.00

63A4Pin
R67CEE463
List Price RM368.00

63A5Pin
R67CEE563
List Price RM405.00



3P + E



3P + N + E

32A4Pin
R67CEE432
List Price RM280.00

32A5Pin
R67CEE532
List Price RM285.00

冷藏货柜防水插座开关
Switch Socket for Reefer Container

32A4Pin - 3hr

R67CEE432-3

List Price RM285.00

Please refer to pages 26,27,28 for Plugs
插头在26,27,28页



67CEE SERIES

67CEE系列防水插座·开关

IP67

56 Series Industrial Sockets IP56

56系列防水插头/插座 IP56



15A 3Pin
56CV315RP
List Price RM95.00



16A 4Pin	
56CV416	56PA416
List Price RM125.00	List Price RM63.00



16A 5Pin	
56CV516	56PA516
List Price RM154.00	List Price RM73.00



20A 3Pin	
56CV320	56PA320
List Price RM127.00	List Price RM71.00



20A 4Pin	
56CV420	56PA420
List Price RM136.00	List Price RM73.00



20A 5Pin	
56CV520	56PA520
List Price RM163.00	List Price RM82.00



32A 3Pin	
56CV332	56PA332
List Price RM149.00	List Price RM82.00



32A 4Pin	
56CV432	56PA432
List Price RM168.00	List Price RM94.00



32A 5Pin	
56CV532	56PA532
List Price RM180.00	List Price RM103.00

56 SERIES
56系列防水插头/插座

IP56



56SO Series Socket

56SO 系列
防水插座



	3Pin	4Pin	5Pin
16A	N.A.	56SO416	56SO516
		List Price RM69.00	List Price RM73.00
20A	56SO320	56SO420	56SO520
	List Price RM67.00	List Price RM76.00	List Price RM76.00
32A	56SO332	56SO432	56SO532
	List Price RM76.00	List Price RM78.00	List Price RM82.00

32A 3Pole



pdb 56SW332

List Price RM89.00

20A DP w/Neon



pdb WPS220

List Price RM38.00

2-way Switch

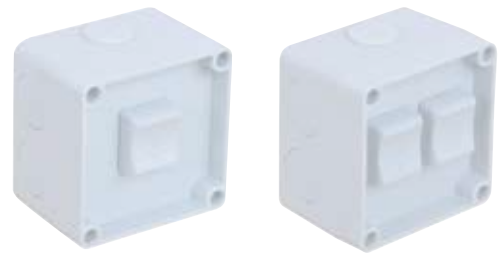

NEM WSC226/1

List Price RM27.00

NEM WSC226/2

List Price RM34.00

13A 平面盖



NEM 56SO313

List Price RM50.00

13A 凹凸盖



NEM 56CSC313T

List Price RM50.00

3 Pole Isolator



NEM

WHT20 (20A)

List Price RM40.00

WHT35 (35A)

List Price RM40.00

WHT63 (63A)

List Price RM53.00



凹凸盖

NEM 56UKC-DG

List Price RM82.00



凹凸盖

NEM 56CV313T

List Price RM62.00



平面盖

NEM 56CV313

List Price RM62.00



NEM 56P313

List Price RM25.00



NEM 56CSC313N

List Price RM52.00



66757	66893	66657	66977M (Metalclad)
List Price RM44.00	List Price RM60.00	List Price RM55.00	List Price RM65.00



20A DP w/Neon

66747	66946M (Metalclad)	66423
List Price RM78.00	List Price RM105.00	List Price RM66.00



66870 / 66871 (2-way)	66872	66873	66874	66878B
LP RM43.00/44.00	List Price RM48.00	List Price RM54.00	List Price RM63.00	List Price RM50.00



Universal Socket c/w Neon

32A DP w/Neon

66827/1	66827/2	66320
List Price RM36.00	List Price RM55.00	List Price RM40.00



Page 53 页



Page 53 页



Page 53 页



Page 54 页



Page 54 页











USB / SOCKETS / TIMERS

开关插座 / 转换开关 / 浮球 / 定时器

开关插座
转换开关/浮球



Universal Socket c/w USB				
		 Black 黑	 Silver Grey 灰银	
	NLG C1012 List Price RM25.00	NLG C1012 - B List Price RM36.00	NLG C1012 - S List Price RM36.00	NLG C2022 List Price RM38.00

Universal Socket 13A				
				
	NLG C1007 List Price RM10.50	NLG C2007 List Price RM20.00	NEM 827L List Price RM10.00	NEM 8272L List Price RM19.00

32A DP c/w Neon	
	NEM PD32 List Price RM11.50

Weatherproof Skt Cover	
	NOVEX NWPB-33 List Price RM9.50

Doorbell (AC240v)	
	TECNO Q302 List Price RM40.00

Change-over 1-0-2		
	C63 4 pole Changeover (1-0-2) c/w PVC Enclosure Box	32 A 4 pole Changeover (1-0-2) with Interlock
	JP040039PEB List Price RM136.00	JP032039ME LP RM90.00

Float Switch				
	MAC3-2	MAC3-5	MAC3-7	MAC3-10
	2 meter	5 meter	7 meter	10 meter
	LP RM23.00	LP RM37.00	LP RM46.00	LP RM57.00

Type 款型	Description 产品描述	Item Code 型号	List Price 大价 (RM/pc)
	<p>TECNO</p> <p>24hrs Spring reserve timer</p> <p>Time Interval : 15 mins 间隔时间</p>	TEC241	57.00
	<p>TECNO</p> <p>24hrs Spring reserve timer</p> <p>Time Interval : 10 mins 间隔时间</p>	TEC711	90.00
	<p>NEM</p> <p>3 module 24hrs Timer (Din-rail type)</p> <p>Time Interval : 30 mins 间隔时间</p>	TS18	82.00
	<p>TECNO SWITCH</p> <p>2 module 24hrs Timer (Din-rail type)</p> <p>Time Interval : 30 mins 间隔时间</p>	OR102	75.00
	<p>TECNO SWITCH</p> <p>1 module 24hrs Timer (Din-rail type)</p> <p>Time Interval : 30 mins 间隔时间</p>	OR101	60.00
	<p>Crompton</p> <p>1 module 24hrs Digital Timer (Din-rail type)</p> <p>7 Days / 6 Preset Programs</p>	CCD24	55.00
	<p>NEM</p> <p>Digital 13A Plug-in Timer (24hrs 7 days programmable)</p> <p>20 Preset Programs</p>	MDT269	44.00
	<p>NEM</p> <p>13A Plug-in Timer (Analogue)</p> <p>Time Interval : 15 mins 间隔时间</p>	TE104	29.00

24hr-Timer Wiring Diagram

定时器接线图

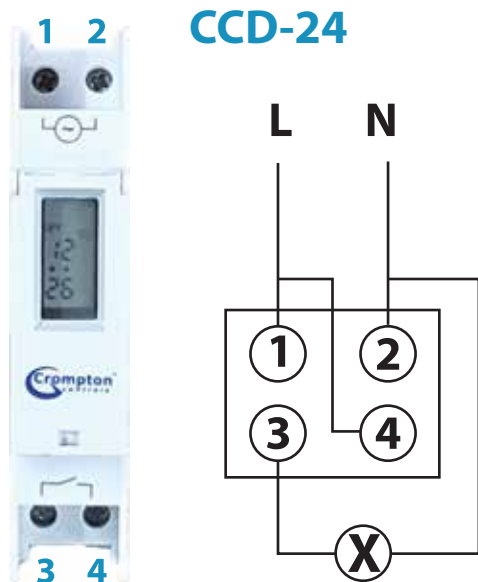
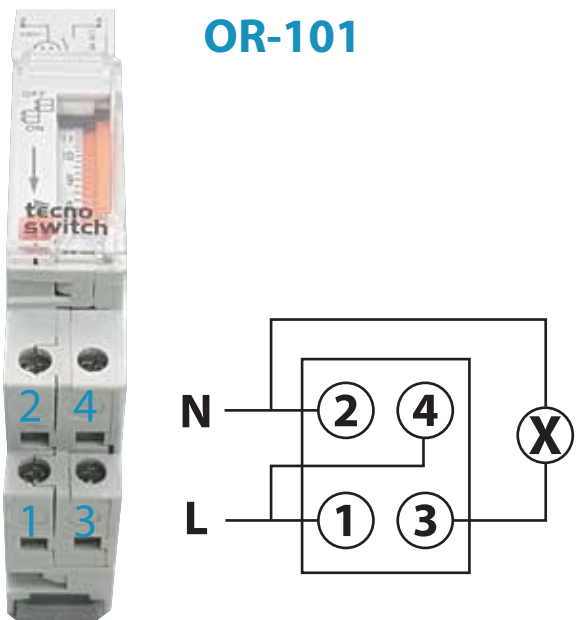
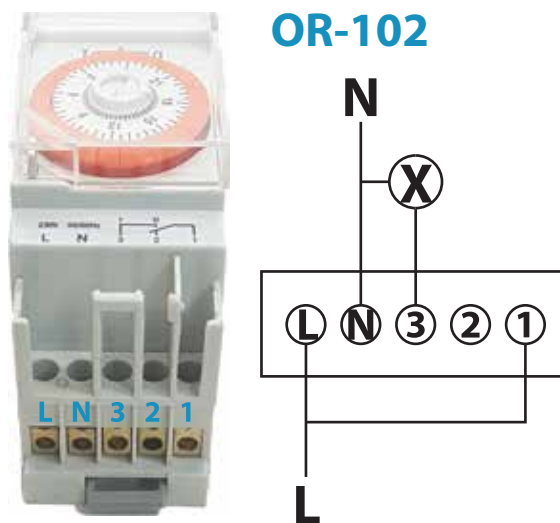
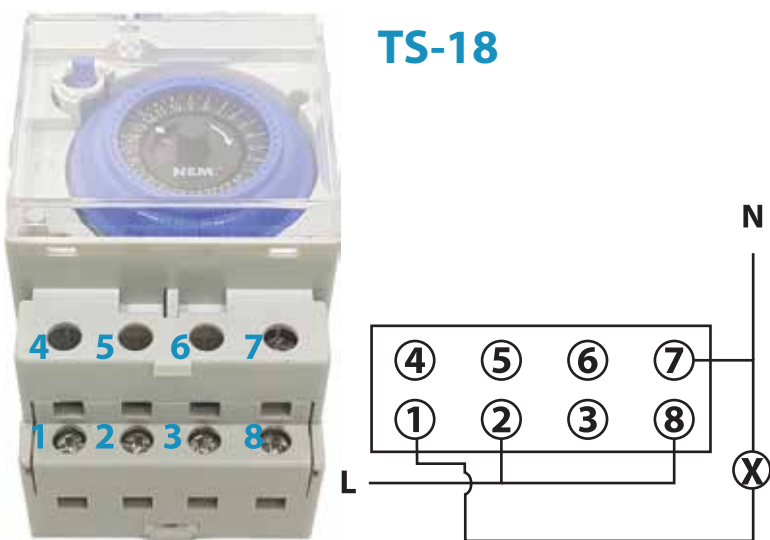
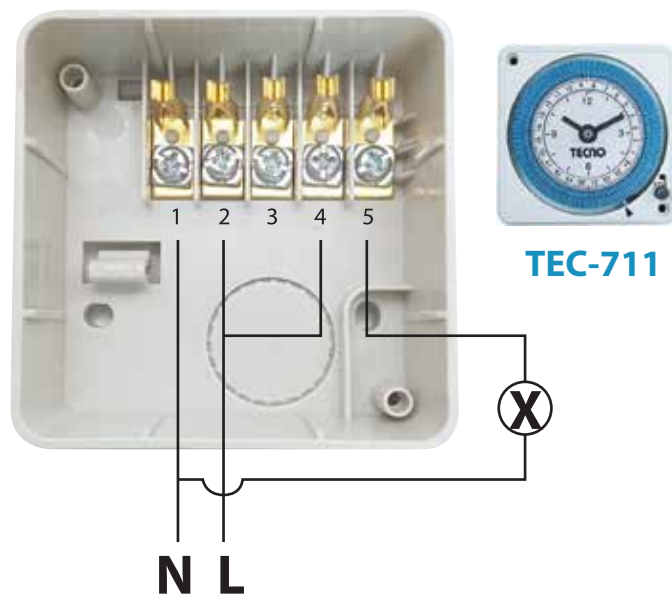
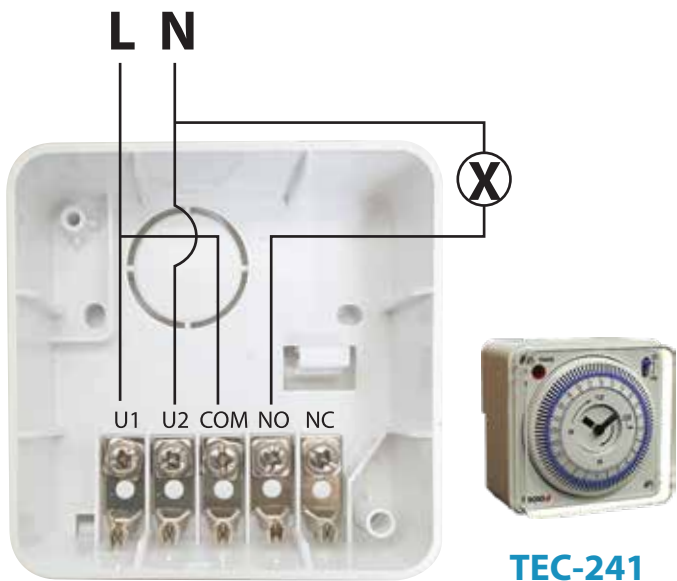



ReyLuc

www.oes.com.my



Type:

ONLINE ELECTRICAL SUPPLY

COPYRIGHT 2022